



The Door to Quality.™

**6000** **SERIES**  
NON-INSULATED INDUSTRIAL DUTY SERVICE DOORS



## The 6000 Series

# ▶ BUILT FOR WORK, ANYTIME, ANYWHERE.

These coiling doors are engineered and designed for maximum strength and durability. Manufactured to stringent code standards, this Series is an industrial product built without shortcuts to provide a high degree of confidence for specifiers and end users. A wide variety of slat profiles, gauges, and color options are available.

### Powder Coat

Select powder coat options from a palette of 188 colors. RAL numbers are provided for each color to ensure that your selection is consistent.



### Hood

Half-hexagonal formed hoods deliver superior structural rigidity and aesthetic appeal.



### Windows

Clear polycarbonate glazed lites approximately 5" x 1-1/8" in size and spaced 7" on center. Pattern options include one or more full rows or groups of windows.



### Service Panel

Guides feature an easily removable 24" inside angle simplifying the replacement of damaged slats or bottom bar.



# SPECIFICATIONS AND OPTIONS

## MODELS

	6241	6220	6221	6200	6201	6180	6181	6244	6266
<b>CURTAIN</b>									
Flat slat	S	—	S	—	S	—	S	S	S
Curved slat	—	S	—	S	—	S	—	—	—
Flat perforated slat [G]	—	—	—	—	O	—	—	—	—
Flat fenestrated slat† [see gauge colors]	O	—	O	—	O	—	O	O	O
24 gauge, Galvanized [G/W/T/B/U/P]	S	—	—	—	—	—	—	—	—
22 gauge, Galvanized [G/W/T/B/U/P]	—	S	S	—	—	—	—	—	—
20 gauge, Galvanized [G/W/U/P]	—	—	—	S	S	—	—	—	—
18 gauge, Galvanized [G/W/U/P]	—	—	—	—	—	S	S	—	—
16 gauge (.050") aluminum [C]	—	—	—	—	—	—	—	S	—
22 gauge, Stainless steel [#4]	—	—	—	—	—	—	—	—	S

<b>BOTTOM BAR</b>									
11 gauge, Double angle [U]	S	S <sup>1</sup>	S <sup>1</sup>	S <sup>1</sup>	S <sup>1</sup>	S <sup>1</sup>	S <sup>1</sup>	—	—
Minimum 1/8" double angle steel [BK]	—	S <sup>2</sup>	S <sup>2</sup>	S <sup>2</sup>	S <sup>2</sup>	S <sup>2</sup>	S <sup>2</sup>	—	—
3/16" Double angle aluminum [C]	—	—	—	—	—	—	—	S	—
1/8" Double angle stainless steel [M]	—	—	—	—	—	—	—	—	S
Extruded aluminum (maximum width 14'4") [C]	O	—	O	—	O	—	O	O	O

<b>HOOD</b>									
24 gauge, Galvanized [G/W/T/B/U/P]	S	S	S	S	S	S	S	S	S
18 gauge (.040") aluminum [C]	—	—	—	—	—	—	—	O	—
24 gauge, Stainless steel [#4]	—	—	—	—	—	—	—	—	O

**GUIDES** Fabricated from three (minimum 3/16") structural steel angles bolted together to form guide channel. Guide angles include curtain stops and flared guides.

Painted steel [BK]	S	S	S	S	S	S	S	S	S
Hot dipped galvanized steel	O	O	O	O	O	O	O	O	O
Cold galvanized steel	O	O	O	O	O	O	O	O	O
Clear anodized finish aluminum <sup>3</sup>	—	—	—	—	—	—	—	O	—
Mill finish stainless steel	—	—	—	—	—	—	—	—	O

<b>OPERATION</b>									
Manual push-up [to 80sq.ft. or ≤8'4" high]	S	O	O	O	O	O	O	O	O
Manual push-up [to 120sq.ft. or ≤8'4" high]	—	—	—	—	—	—	—	O	—
Chain hoist	S <sup>4</sup>	S	S	S	S	S	S	S	S
Motor	O	O	O	O	O	O	O	O	O

**STANDARD DIMENSIONS** Consult factory for larger sizes.

Width	12'0"	20'4"	20'4"	28'4"	28'4"	30'0"	30'0"	14'4"	18'4"
Height	14'4"	20'4"	20'4"	28'0"	28'0"	28'0"	28'0"	18'4"	20'4"

**LOCKING** Manual push-up doors furnished with interior slide bolt locks with padlock provision standard. Chain hoist operated doors furnished with chain hoist keeper suitable for padlocking. Optional bottom bar cylinder locking available.

**WARRANTY** Manufacturer's standard 5-year from date of plant shipment against defects in materials or workmanship. Model 6241 service doors are warranted for one year. Spring wire is warranted for one year. C.H.I.'s obligations are strictly limited to repair or replacement of defective parts and components during the warranty period.

**INSTALLATION** C.H.I. Rolling Steel Doors shall be installed and adjusted according to C.H.I. assembly instructions by trained door service technicians.

S = Standard O = Optional — = Not available G = Gray W = White T = Tan B = Brown U = Unpainted galvanized C = Clear anodized #4 = #4 polished P = Powder coat BK = Black  
 † = fenestrations or windows are 5" x 1-1/8" on 7" centers. Specify number and location. 1 Standard on doors up to 14'4" wide. 2 Standard on doors over 14'4" wide. 3 Wall and pack-out angles painted steel. 4 Standard for doors over 10'4" and 8'4" wide.

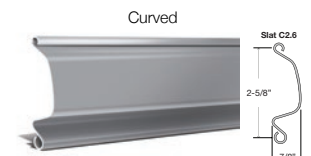
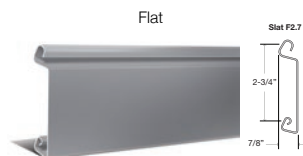
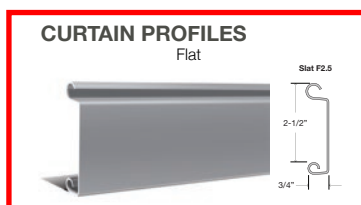

### FINISHES

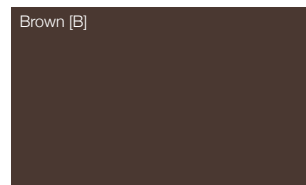
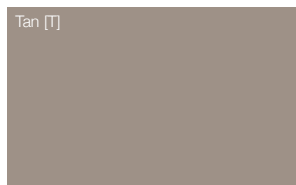
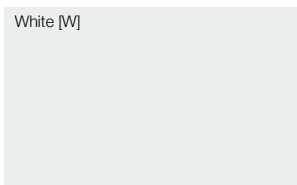
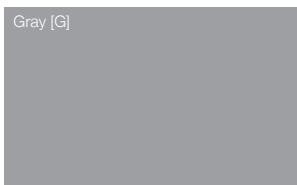

## MOUNTING OPTIONS

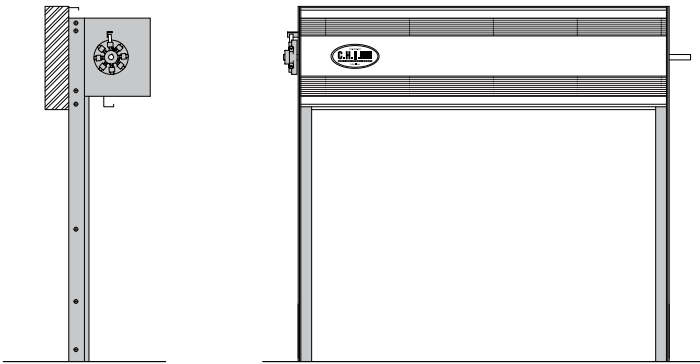

**Face of Wall**

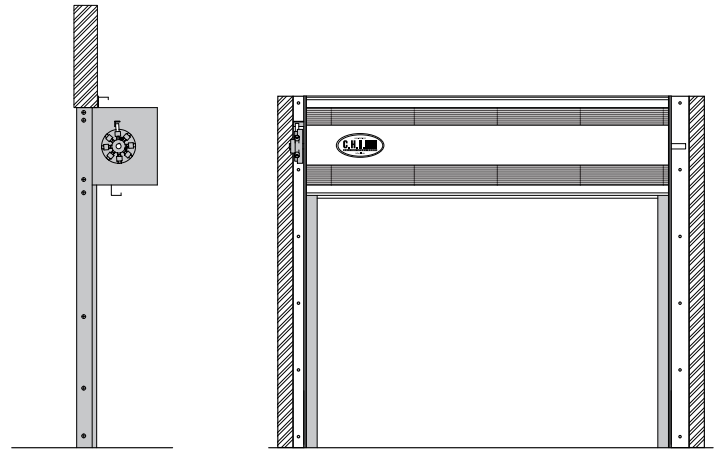
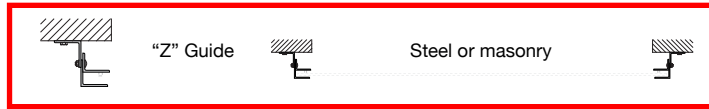

**Between Jamb**



Standard service doors are built to order to fit specific dimensions up to 30'0" wide, 24'4" high. Consult factory for larger doors not listed. If headroom is critical, consult factory to determine headroom requirements for your application.

For downloadable specifications, please visit our website at [www.chiohd.com](http://www.chiohd.com) or call our AIA hotline at, 800-590-0559.

**ASK YOUR DOOR PROFESSIONAL AT:**



The Door to Quality.™

[www.chiohd.com](http://www.chiohd.com)